



Wood Plank & Stone Tile Effect - Suitable For All Rooms

PREPARATION & INSTALLATION METHOD

Please Note:

All subfloors should be smooth and dust free with a flatness tolerance not exceeding more than 3mm (1/8") in a 3m (10') span.

Any unevenness over 4.7mm (3/16") must be sanded down or levelled.



Preparation

For preparation and installation guidelines, please scan QR Code to view Hydro Step video.

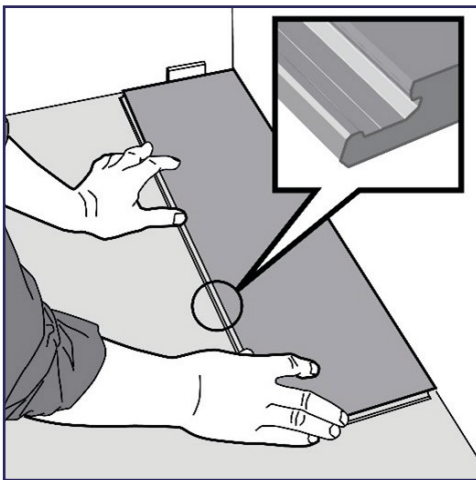

Step 1

First plank, first row:

Place a 6-10mm thick spacer to the left and position the plank against the wall.

Later, after 3 rows, you can easily position the flooring 6-10mm from the wall and install spacers.

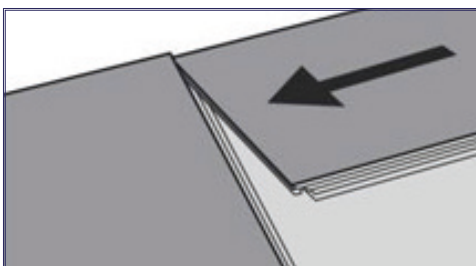

Step 2

Second plank, first row:

Place this plank gently and tight to the short end of the first one.

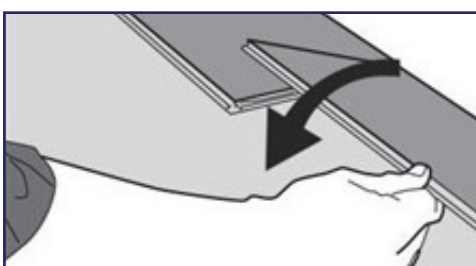

Step 3

Fold the plank down in a single action movement. During the fold down, make sure the planks are tight against each other.

Afterwards press or slightly knock at the short end just installed.

Hydro Step

SPC Vinyl Click Flooring



Wood Plank & Stone Tile Effect - Suitable For All Rooms

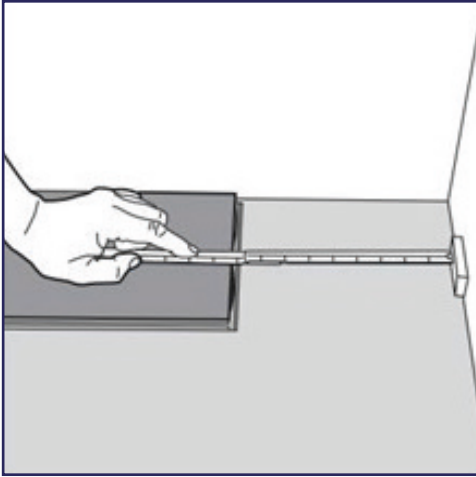

Step 4

At the end of the first row, put a distance of 6-10mm to the wall and measure the length of the last plank to be fitted.

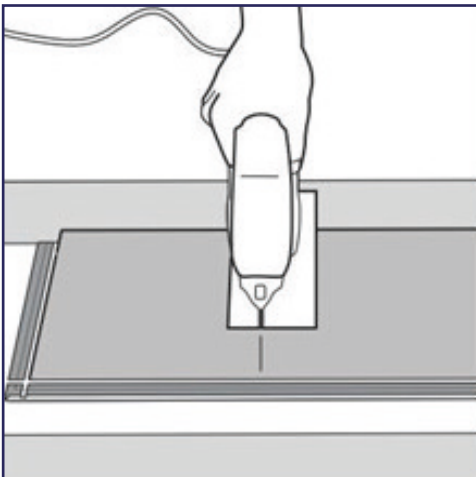

Step 5

Cut with a jigsaw, handsaw or laminate cutter.

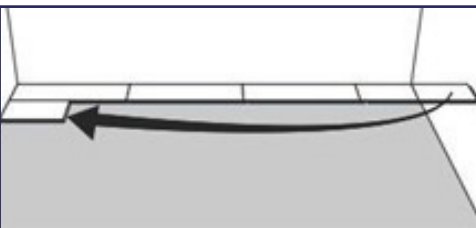

Step 6

Second Row:

Put a spacer against the wall and place first plank of minimum length 30cm.

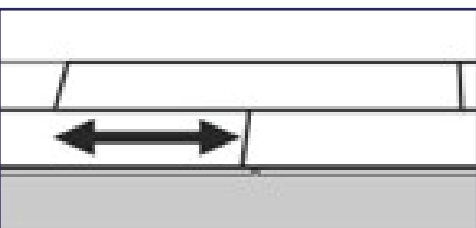

Step 7

General minimum distance between ends of planks in parallel rows shall not be less than 30cm.



Wood Plank & Stone Tile Effect - Suitable For All Rooms

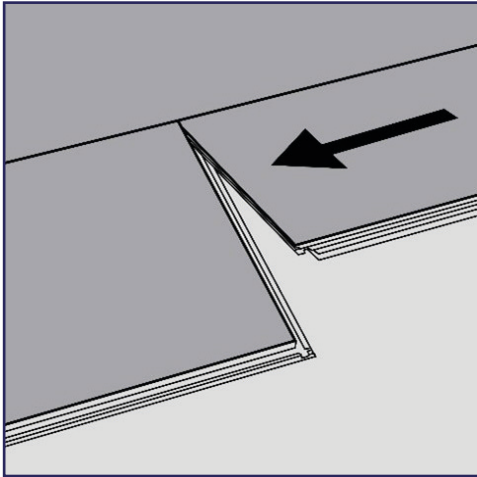

Step 8a

Second plank, second row:

Place the plank **gently and tight** to the short end of the previous plank.

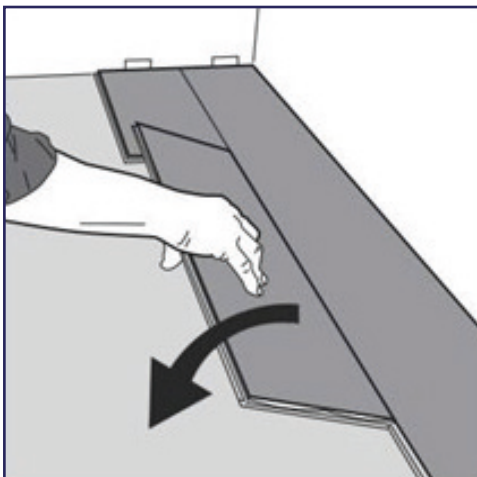

Step 8b

Fold the plank down in a single action movement with a slight press to the left to the short end of the previous plank.

During the fold down, make sure the planks are tight against each other.

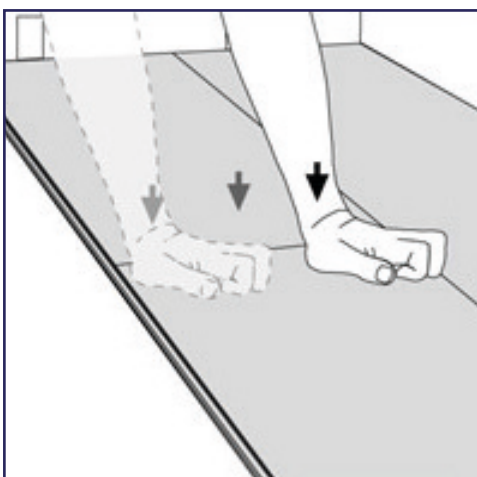

Step 8c

Press or knock slightly along the short end of the installed plank until a click is heard.

Do not force or use mallet on seam.

Hydro Step

SPC Vinyl Click Flooring



Wood Plank & Stone Tile Effect - Suitable For All Rooms

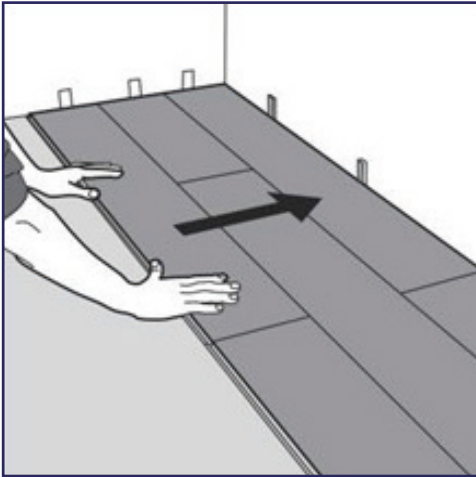

Step 9

After 2-3 rows:

Adjust the distance to the wall by pulling floor out and placing spacers of 6-10mm against wall.

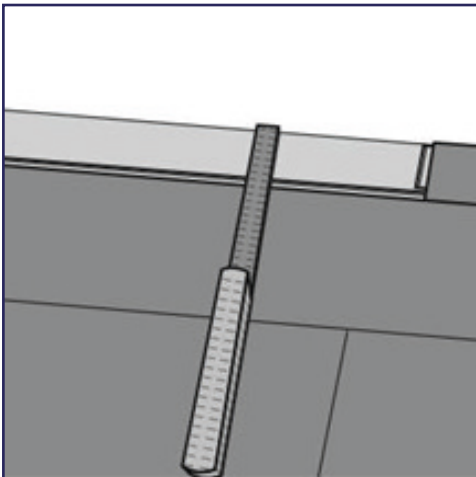

Step 10

Last row (and perhaps also first row):

Minimum plank width should be at least 50mm. Remember to allow for a gap of 6-10mm to wall.

Tip! Put a spacer before measuring

Cut the plank length wise and glue the short ends.



Wood Plank & Stone Tile Effect - Suitable For All Rooms

DISASSEMBLY (WITHOUT TOOL)

Your floor can very easy be disassembled, which enables replacement during installation and also once installed.

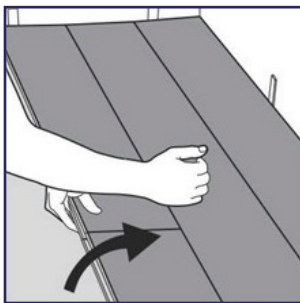

Step 1

Separate the whole row by carefully lifting up and slightly knocking just above the joint.

Fold up and release the whole long side.



Step 2

Disassemble the planks by sliding horizontally. **Do not fold up!**

Lifting up will damage end profiles.

SPECIAL INSTALLATIONS

- When doing last row where angle fit is not possible, cut the tongue at the same time you cut the length of the plank and install as shown below.
- Note that the smallest width of a plank is 5cm at the last row – if not - first row must be adjusted. This can easily be calculated when measuring the room width before installation. Cut off the locking element with a chisel, push the planks horizontally together and glue planks together with vinyl seam sealer.
- If necessary, place some spacers between the last plank and the wall to keep the planks together during the curing time of the glue

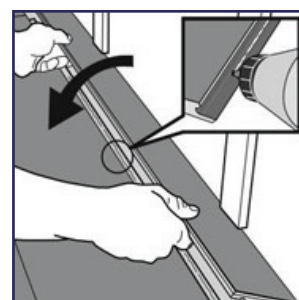

Hydro Step

SPC Vinyl Click Flooring



Wood Plank & Stone Tile Effect - Suitable For All Rooms

Radiator Pipes

Installation at radiators. Drill the holes 20mm larger than the diameter of the pipes.

